



Environmental Product Declaration Aluminium Door Systems



Environmental Product Declaration

This environmental product declaration (EPD) is for a CEN standard door system produced by Kawneer (UK) Ltd in Runcorn, England. It has been developed using a Life Cycle Analysis (LCA) study that we commissioned in 2016 and carried out in accordance with the principles of ISO 14040:2006, ISO 14040:2006 and EN 15804:2012.

This EPD discloses the average impacts and resources used to supply a standard Kawneer door system.

Kawneer Door Systems

Kawneer door ranges are designed to offer optimum weather and thermal performance. Multiple ranges are available to meet bespoke customer requirements. This study considers the AA 545 swing door range.

Analysis

This EPD has been developed using an LCA study undertaken by 3Keel LLP, an independent third party sustainability consultancy.

Kawneer (UK) Ltd

Astmoor Road
Astmoor Industrial Estate
Runcorn, Cheshire, WA7 1QQ
United Kingdom

Product profile

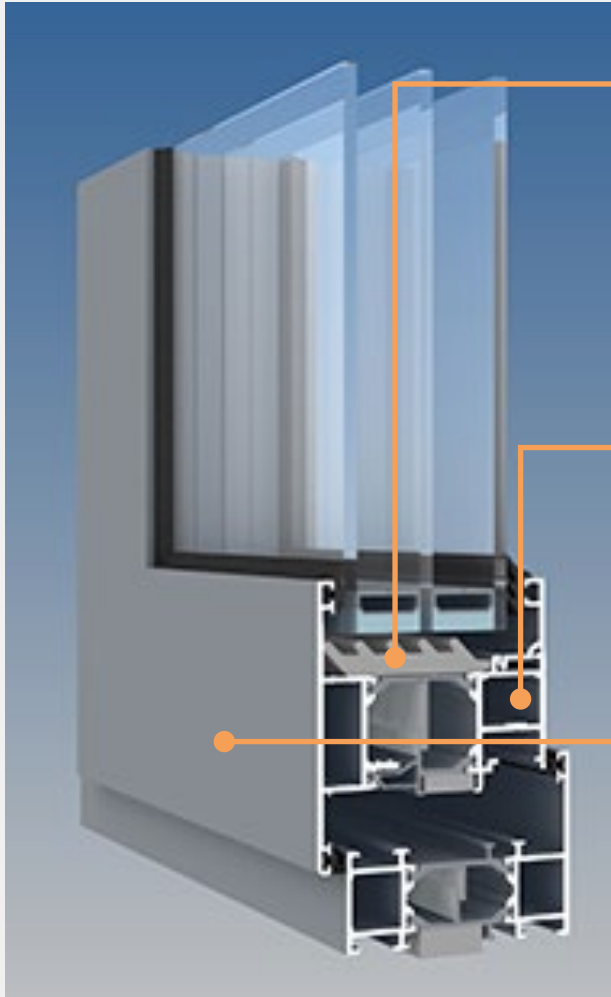

Thermal break

- Reduces temperature loss through the framing system.
- A polyamide thermal break offers enhanced thermal performance improving insulating properties of the door.
- Compliant with Document L.

Frame

- Aluminium profile providing optimal weather and thermal performance.
- Low U_w -value range from 0.6 – 1.6 W/m²K

Coating

- Kawneer Permacover™ high quality polyester powder paint finish provides outstanding resistance to environmental conditions thereby extending the life of the door system.
- Also available in a range of subtle anodised colours which have been developed specifically for architectural glazing systems.

Product Description

The door system assessed in this study is a standard door system exclusive of glazing and furniture. Kawneer door systems are designed with aesthetics and energy efficiency in mind, both in terms of real world customer use and its production process.

Materials

- Kawneer door systems use simple materials that maximise the opportunity for reuse and recycling at their end of life.
- Frame materials are 100% recyclable and Kawneer extruded aluminium includes more than 75% recycled content.

Production process

The door frame assessed in this EPD are produced by Kawneer in Runcorn, England. Aluminium billets containing primary and secondary aluminium are extruded to form the profile of the frame and assembled with a thermal break. Extrusions are then aged before being coated, packaged and supplied to customers for assembly and furniture installation. Doors are then delivered to customers for fabrication and subsequently construction sites for fitting and glazing installation.

Many of Kawneer's door systems are listed in the BRE Global Green Guide and achieve A and A+ ratings and are suitable for projects that require sustainable and environmental advantages.

Material Declaration

Table 1: Median material composition of a CEN standard door frame

	Weight (kg)	%
Frame	17.32	86%
Thermal breaker	2.17	11%
Coating	0.56	3%
Total	20.05	100%

EPD Parameters

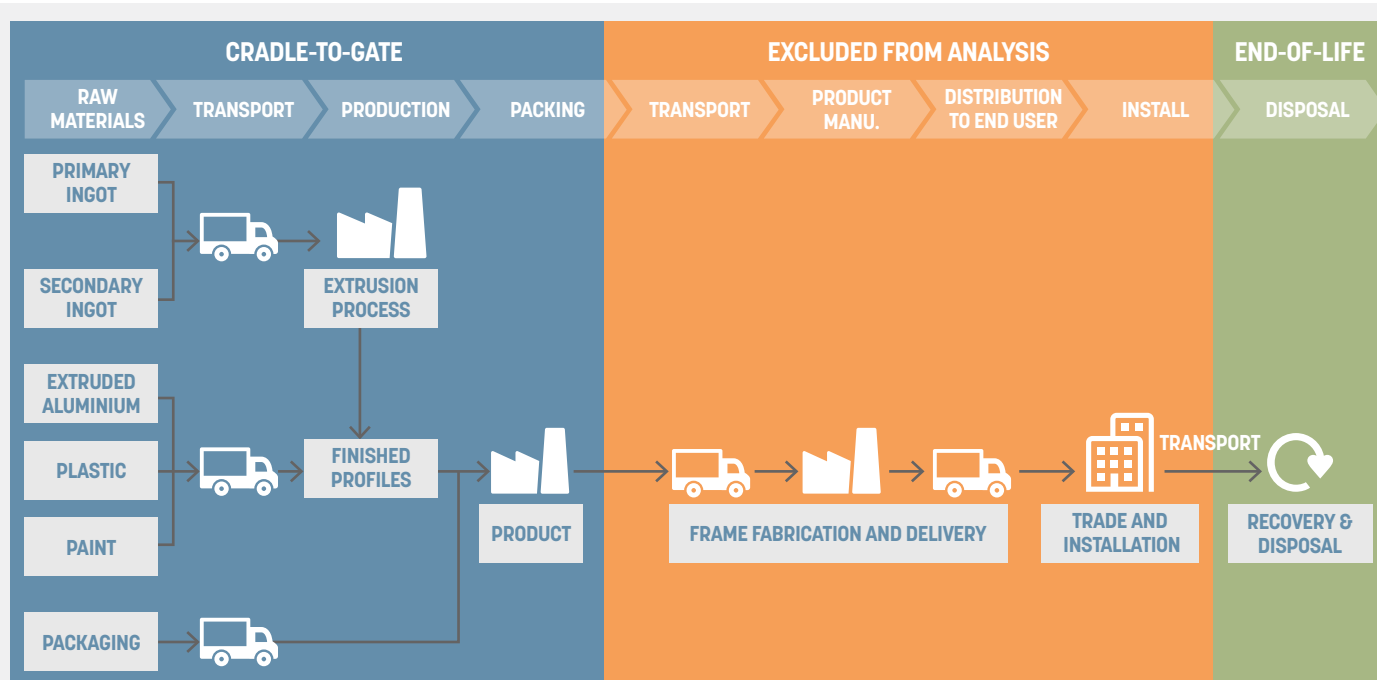

An LCA determines the cradle-to-grave impacts of a product. At Kawneer we take all our responsibilities very seriously. We're dedicated to creating products and systems that promote integrated, whole-building design practices. LCA helps us measure and review our products to minimise the resources and impacts associated with their use from cradle-to-grave.

This EPD covers 'cradle-to-gate' + end of life processes.

Declared Unit

The declared unit is a single CEN standard door frame and frame system (1000 mm x 2000mm).

Key Considerations

- Kawneer production and supply chain data was used for extrusion and coating processes.
- Data were provided for 2015 production and were collated under EN 15804 guidelines.
- All significant inputs were included covering more than 95% of inputs and neglected inputs are likely near 0%.
- The analysis includes the resources and impacts associated with the production of a frame ready for assembly by Kawneer's customers. It excludes final assembly, furniture, and then building installation.

Assumptions

- UK construction sector waste statistics provided by Defra (2015) were used to assess the end of life management routes.
- Aluminium has a high market value and has a strong recycling rate in the UK construction industry. Recycling of aluminium has a substantially lower environmental impact than the production of virgin alloy, however this analysis only considers the environmental benefits of Kawneer's use of recycled aluminium in purchased billets and third party supplied extrusions.
- Ecoinvent 3.2 was used to assess the environmental impact of purchased materials and processes.

Environmental Metrics and Resources

This study was conducted following the principles and analytical requirements of EN 15804 regarding the creation of EPDs for construction products. The standard requires that the lifecycle stages assessed and disclosure of environmental criteria adhere to specific environmental, waste and resource flows in accordance with CML 2001 methods and characterisation factors.

Environmental impact

- Global Warming
- Ozone Depletion
- Acidification
- Eutrophication
- Photochemical Ozone Creation
- Abiotic Resource Depletion (Energy)
- Abiotic Resource Depletion (Fossil Fuels)

Waste flows

- Hazardous waste
- Non-hazardous waste
- Radioactive waste

Resource use

- Primary Energy
- Fresh Water

LCA Results

Life Cycle Assessment of CEN Standard Door Frame System

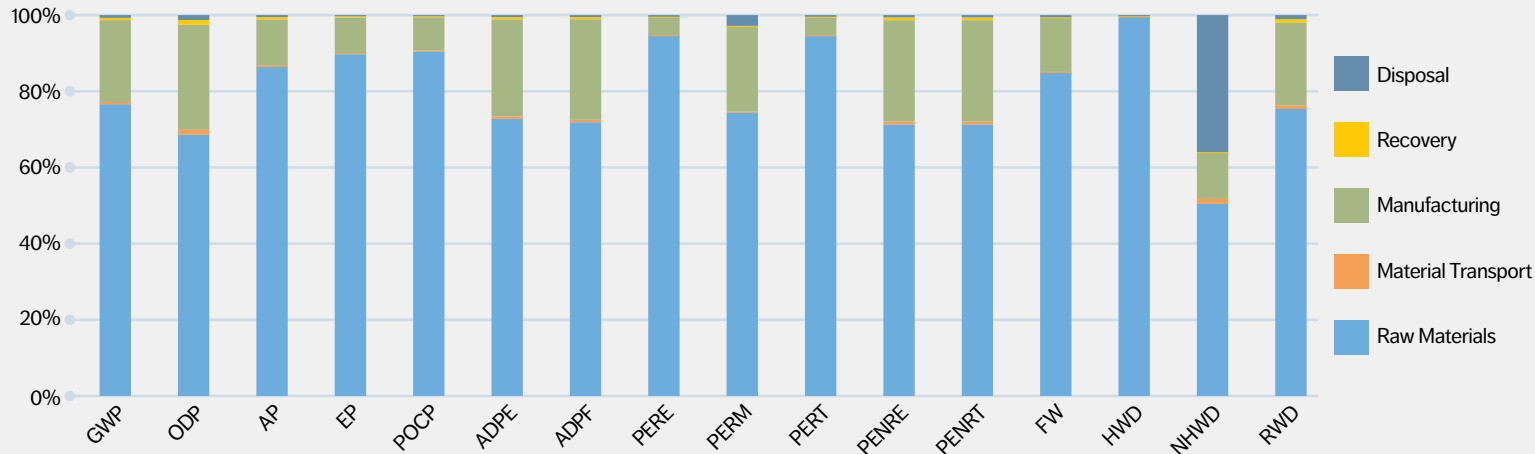

GWP = Global Warming Potential (Climate Change); ODP = Ozone Depletion Potential; AP = Acidification Potential for Soil and Water; EP = Eutrophication Potential; POCP = Photochemical Ozone Creation; ADPE = Abiotic Depletion Potential – Elements; ADPF = Abiotic Depletion Potential – Fossil Fuels Resource use; PERE = Use of renewable primary energy excluding renewable primary energy resources used as raw materials; PERM = Use of renewable primary energy resources used as raw materials; PERT = Total use of renewable primary energy resources; PENRE = Use of non-renewable primary energy excluding non-renewable primary energy resources used as raw materials; PENRT = Total use of non-renewable primary energy resources FW = Net use of fresh water; HWD = Hazardous waste disposed; NHWD = Non-hazardous waste disposed; RWD = Radioactive waste disposed;

- The majority of impacts associated with the production and supply of doors occur before they reach Kawneer as part of the raw material supply that goes into the extrusion process. This is expected and consistent with other analyses assessing the impacts of extruded aluminium products.

- Manufacturing impacts are the second biggest contributor across almost all impact and resource categories, except for waste.

Product Range Variability

Global Warming Potential

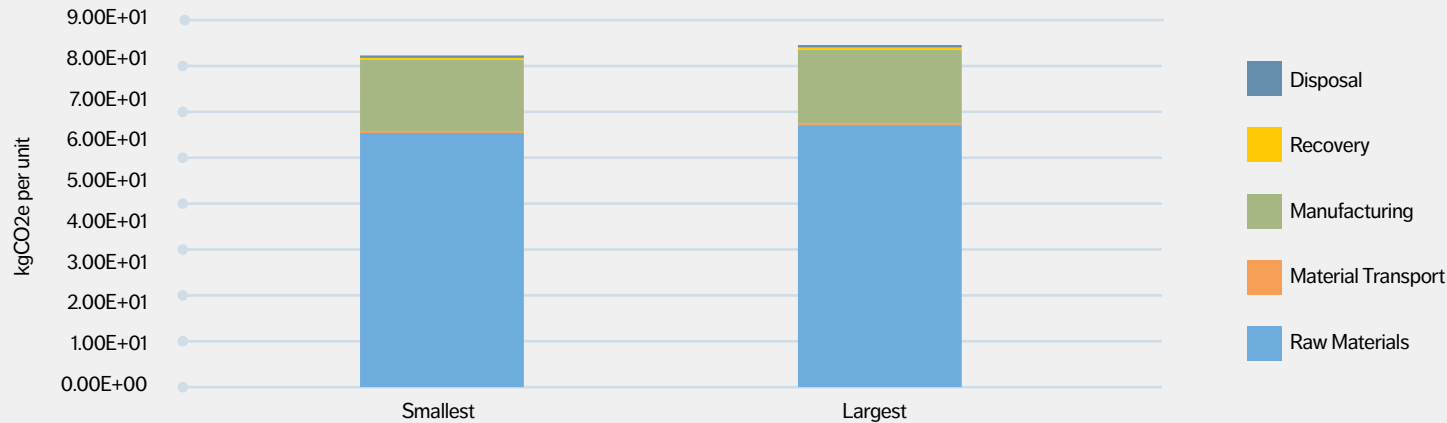

- A median product profile was used to calculate the average impact of Kawneer door systems.

- The specific door profile and format supplied by Kawneer may be different depending on:
 - Specific product type
 - Door dimension
 - Profile
 - Bead type

- Although the specific impact may vary, the relative contribution to each life cycle stage does not change as the materials used are adjusted in a similar proportions.

Interpreting LCA Results (GWP)

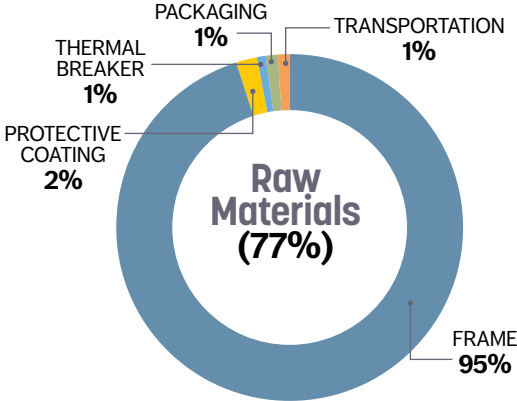

Raw Material Impacts

- Aluminium material for the frame is the single biggest raw material impact.
- Using recycled, rather than primary (virgin), aluminium can reduce the impact of its use by over 85%.

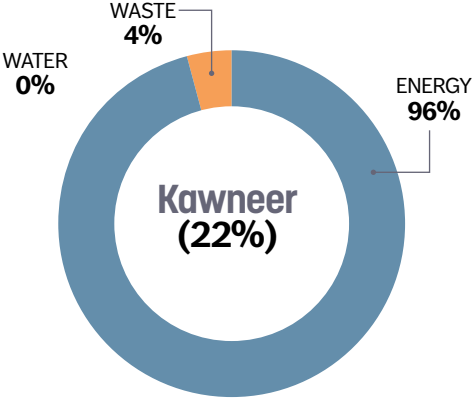

Extrusion Impacts

- The energy used in the extrusion process – particularly electricity – is the primary contributor to Kawneer’s manufacturing impact.
- Improving production efficiency and using renewable energy within the production process can significantly reduce these impacts.

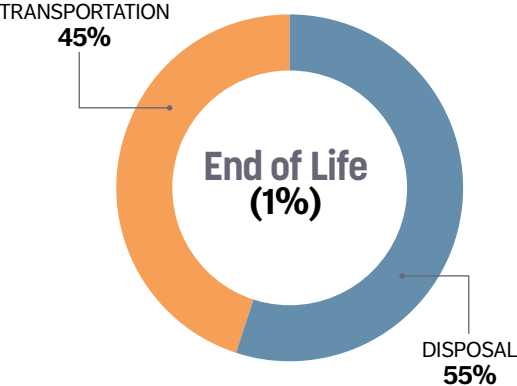

End of Life Impacts

- Recycling aluminium when a door frame is removed from a building will substantially reduce its disposal impacts.
- Approximately 87% of all construction waste is recovered in the UK and aluminium frames are considered to have a 98% recovery rate.

LCA Results Data Table (per CEN Standard door and frame system)

	ENVIRONMENTAL PRODUCT DECLARATION LIFECYCLE STAGE MODULE		CRADLE-TO-GATE			END-OF-LIFE	
	Indicator	Unit	A1 Raw Materials	A2 Material Transport	A3 Manufacturing	C2 Transport to Disposal	C4 Disposal*
Environmental impact per unit	Global Warming Potential (GWP)	kg CO2e	1.12E+02	8.504E-01	3.141E+01	8.787E-01	1.054E+00
	Ozone Depletion Potential (ODP)	kg CFC-11e	8.38E-06	1.561E-07	3.378E-06	1.481E-07	1.560E-07
	Acidification Potential (AP)	kg SO2e	6.79E-01	3.876E-03	9.430E-02	4.916E-03	4.068E-03
	Eutrophication Potential (EP)	kg PO43-e	2.27E-01	7.673E-04	2.354E-02	8.813E-04	8.168E-04
	Photochemical Ozone Creation (POCP)	kg C2H4e	4.89E-02	1.433E-04	4.715E-03	1.543E-04	1.418E-04
	Abiotic Depletion Potential - Elements (ADPE)	kgSb e	6.98E-01	6.207E-03	2.445E-01	5.474E-03	5.047E-03
	Abiotic Depletion Potential – Fossil Fuels (ADPF)	MJ e	1.48E+03	1.300E+01	5.423E+02	1.145E+01	1.066E+01
Resource use per unit	Primary Energy – renewable energy (PERE)	MJ NCV	3.65E+02	1.686E-01	1.856E+01	5.153E-02	1.740E+00
	Primary Energy – renewable energy as raw materials (PERM)	MJ NCV	3.20E-02	9.552E-05	9.646E-03	1.942E-05	1.215E-03
	Total primary renewable energy resources (PERT)	MJ NCV	3.65E+02	1.687E-01	1.856E+01	5.155E-02	1.741E+00
	Non-renewable primary energy (PENRE)	MJ NCV	1.22E+02	1.358E+01	4.539E+02	1.228E+01	1.063E+01
	Total use of non-renewable primary energy (PENRT)	MJ NCV	1.22E+02	1.358E+01	4.539E+02	1.228E+01	1.063E+01
	Fresh water (FW)	m3	1.38E+00	2.494E-03	2.321E-01	1.173E-03	9.333E-03
Waste to disposal	Hazardous waste disposal (HWD)	kg waste	1.68E-01	7.911E-06	4.402E-04	3.965E-06	1.887E-04
	Non-hazardous waste disposal (NHWD)	kg waste	2.31E+01	6.070E-01	5.557E+00	5.682E-02	1.647E+01
	Radioactive waste disposal (RWD)	kg waste	6.94E-03	8.861E-05	1.999E-03	8.391E-05	9.723E-05

* The Disposal Module includes waste processing that cannot be separated out.

References

BRE Global. BRE Environmental Profiles 2013: Product Category Rules for Type III environmental product declaration of construction products to EN 15804:2012+A1:2013. PN 514. Watford, BRE, 2014.

BSI. Sustainability of construction works Environmental product declarations Core rules for the product category of construction products. BS EN 15804:2012+A1:2013. London, BSI, 2013.

BSI. Environmental labels and declarations – Type III Environmental declarations –Principles and procedures. BS EN ISO 14025:2010 (exactly identical to ISO 14025:2006). London, BSI, 2010.

BSI. Environmental management –Life cycle assessment Principles and framework. BS EN ISO 14040:2006. London, BSI, 2006.

BSI. Environmental management – Life cycle assessment –Requirements and guidelines. BS EN ISO 14044:2006. London, BSI, 2006.

Weidema, B.P.; Bauer, Ch.; Hischier, R.; Mutel, Ch.; Nemecek, T.; Reinhard, J.; Vadenbo, C.O.; Wernet, G, 2013, The ecoinvent database: Overview and methodology, Data quality guideline for the ecoinvent database version 3, www.ecoinvent.org

Company information

Kawneer UK Ltd is part of Arconic Building and Construction Systems, and enjoys the extensive resources of the entire Arconic organisation, allied to the specific glazing systems experience of Kawneer's many operations around the world. As a result of this our partners and customers have direct access to one of the largest pools of technical expertise in the construction industry.



Authorities

ISO 9001:2008
BS EN 12020
BS 3987
BS 6496
BS 6375 Part 1
BS 6375 Part 2
BS 4873
PAS 24:2012
BS 4255 Part 1



3Keel LLP
11 Standingford House
26 Cave Street
Oxford, OX4 1BA
United Kingdom

Tel: +44 (0) 1865 236 500
E-mail: research@3Keel.com



Kawneer UK Limited
Astmoor Road
Astmoor Industrial Estate
Runcorn, Cheshire
WA7 1QQ
United Kingdom
Tel: + 44 (0)1928 502500
Fax: + 44 (0)1928 502501

Kawneer UK London Office
12 Berwick Street
Soho
London
W1F 0PN
United Kingdom
Tel: +44 (0)207 287 5911

3Keel LLP has conducted this life cycle assessment in accordance with data provided by Kawneer (UK) Ltd. 3Keel has exercised due care in assessing the quality of information provided, but has not independently verified information provided by others.